

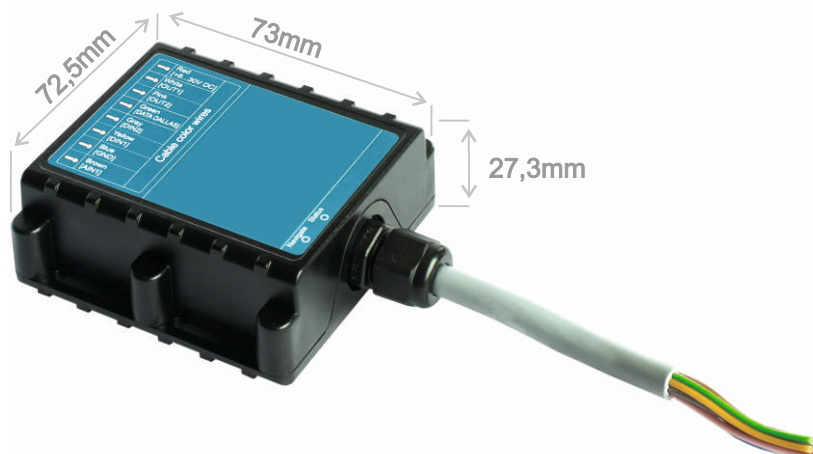

# FM1204

## GPS/GLONASS/GSM vehicle tracker



### Description

Fm1204 is Waterproof (Ip67) realtime tracking device terminal with GPS/GLONASS and GSM connectivity, which is able to collect device coordinates and other useful data and transfer them via GSM network to server. This device is perfectly suitable for applications where location acquirment of remote objects is needed: fleet management, water transport, motorcycle, public transport, car rental companies, logistics companies and so on.

### Applications

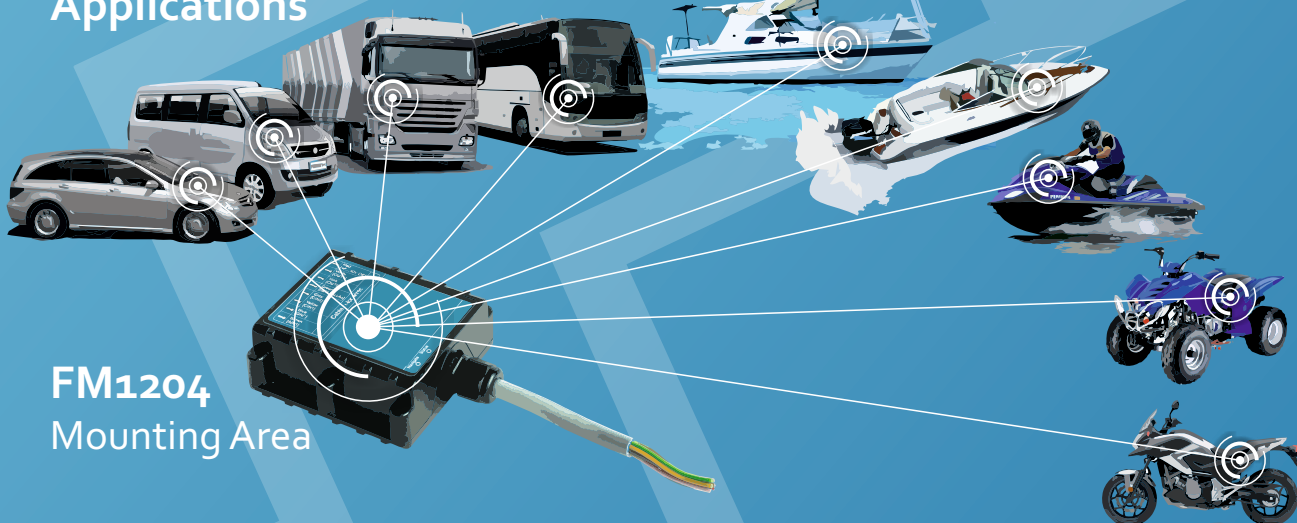

### FM1204 Mounting Area

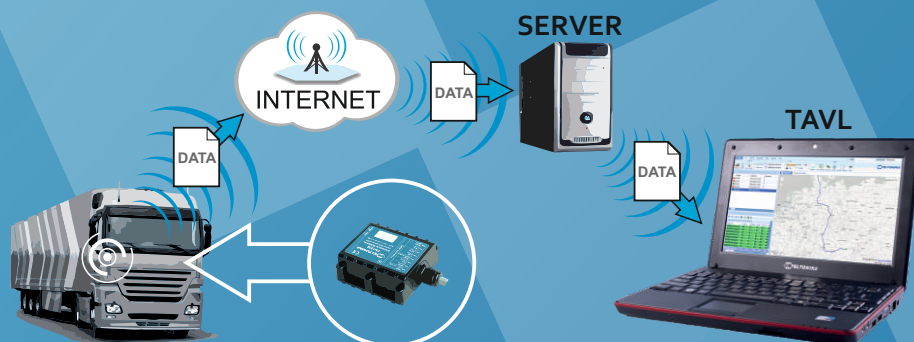

FM1204



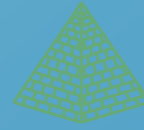

# APEXS

## Accessories/features

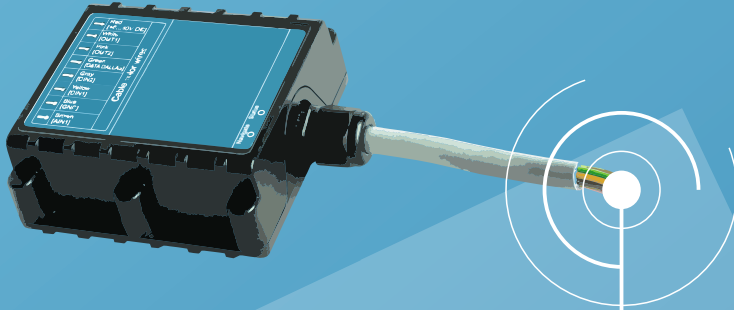

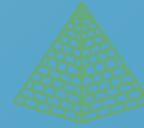

## Features

- Hermetic enclose IP67 allow use device in place where is contact with water
- Internal High Gain GSM antenna and Internal High Gain GPS/GLONASS antenna allow mount FM1204 much easier
- Real Time tracking
- Smart data acquisition - based on time, distance, angle, ignition and I/O events allow to have precise online tracker
- Sending acquired data via GPRS (TCP/IP and UDP/IP protocols)
- Smart algorithm of GPRS connections for GPRS traffic saving
- Operating in roaming networks by preferred GSM providers list
- Events from I/O elements detection and sending via GPRS or SMS
- Scheduled 24 coordinates SMS sending when GPRS not available
- 5 geofence zones (rectangular or circle)
  - Auto Geofencing created for car towing detection and car theft prevention
- Deep Sleep mode (less than 2 mA power consumption)
- FOTA (firmware updating via GPRS)
- Small and easy to mount case
- 3 operational modes (Home, Roaming, Unknown) based on operator
- Integrated scenarios:
  - Overspeeding to secure driver and prevent penalties
  - Authorized driving (1-Wire® iButton ID keys up to 50 iButton keys) use to prevent stealing or indicate drivers
  - Immobilizer function
  - Trip start and end detection
- FM1204 has large internal Flash memory (16MB)
  - The memory can save 100 350 records or up to 120 days data with the standard configuration
  - It is possible to disable data sending in Roaming and then device will store data in its memory till back to home area
- FM1204 can be used without a GSM connection
  - Additional function – Offline data logging – allows to download acquired data from FM1204 to PC via cable and later to upload it to TAVL server. This functionality helps to avoid high GPRS bills caused by expensive roaming operators and keep acquired data save until it is downloaded to PC
- FM1204 supports a remote logs reading
  - FM1204 supports remote diagnostic logs functionality using GPRS. Possible issues resolving becomes faster. Manufacturer can read logs remotely using SMS/GPRS to diagnose the FM1204 and timely respond to the fault

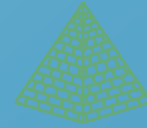

## Specification

### GSM

- Quad-band 900/1800 MHz; 850/1900 MHz
- GPRS class 10 (up to 85,6 kbps)
- SMS (text/data)

### GPS/GLONASS

- NMEA, GGA, GGL, GSA, GSV, RMC, VTG protocol compatible
- 32 channel GPS/GLONASS receiver
- -161 dBm sensitivity

### Interface

- 1 Digital Input Reserved for Ignition Status Monitoring
- 2 Digital Inputs
- 1 Analog Input (10V or 30V range)
- 2 Digital Open-collector Outputs (connecting external relays, LED, buzzers etc.)
- Motion sensor
- 1Wire® temperature sensor
- 1Wire® iButton
- Power supply (+6...+30) VDC
- Hermetic enclose IP67
- Integrated Li-Po back-up battery
- Internal High Gain GSM antenna
- Internal High Gain GPS/GLONASS antenna
- Internal Flash memory – 16MB
- Dimensions: L(72,5mm)xW(73mm)xH(27,3mm)
- 2 Status LEDs
- Configuration and firmware upload (FOTA and via cable )

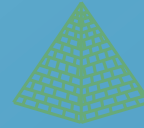

# APEXS

## Accessories

USB to micro USB cable



1Wire® temperature sensor (TTJ)



1Wire® iButton and iButton reader



Analog fuel sensor LLS-AF 20310



Door sensors



Relay 12V/24V



Alarm button



LED

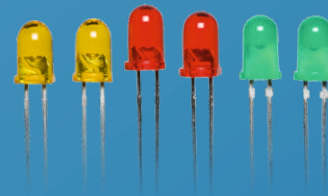

Buzzer







Contact us:



**APEXS, INC.**

Applied Expert Systems & Software Inc.  
We put technology to work for you

-  : Suite 714 EGI City By The Sea, Maribago, Mactan, Lapu-lapu City, Cebu, Philippines 6015
-  : (6332) 495-2106, 233-0835
-  : [apexsinc@mozcom.com](mailto:apexsinc@mozcom.com)
-  : [www.apexvalue.com](http://www.apexvalue.com)